



Smart Contactless Sanitizer Dispenser

Designed To Kill Covid-19 Effectively

Stay Home

Stay Safe

Save Lives

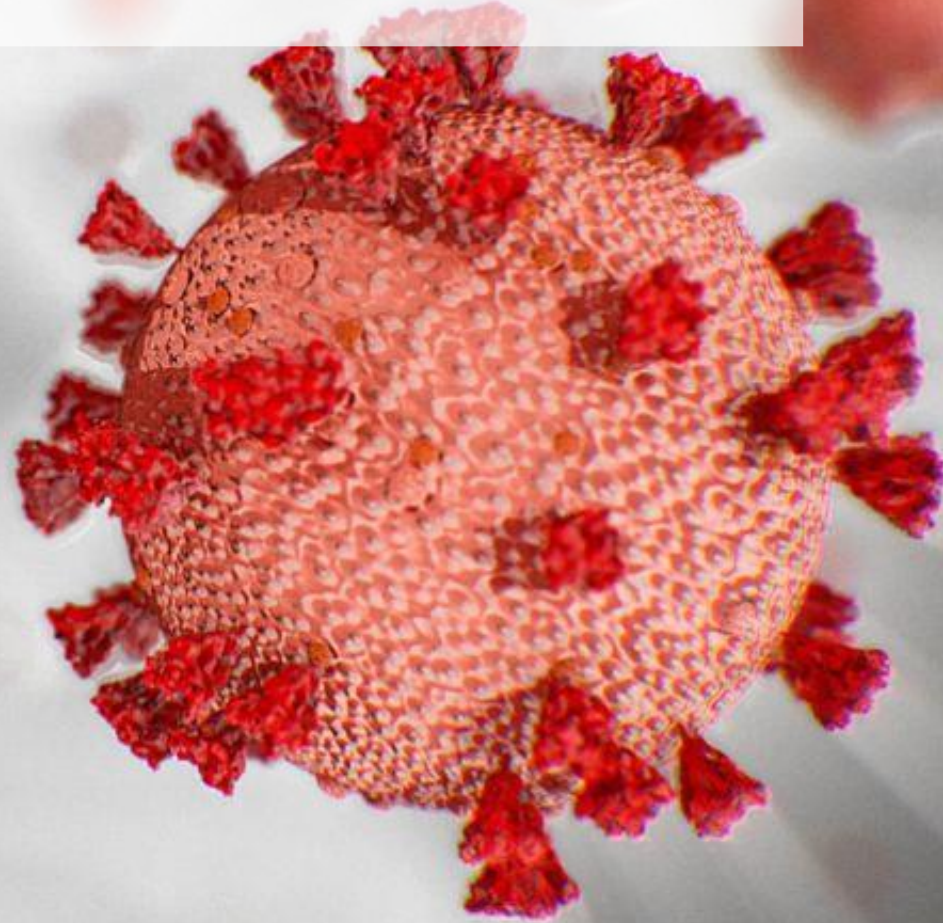

What is Smart Contactless Sanitizer Dispenser ?



- Fully Automated & Contactless
- Integrated with 4 Smart Sensors
- 2 x Wide Angle Nozzle for Maximum Coverage
- Prevent Virus Travel in Aerosols
- Sleek, Modern & Compact Design
- Safe Human Resource
- Cable Free (Approx 4000 times / set of AA battery)
- Flexible mounting options



Competitor's Analysis

- Not fully automated
- Narrow spray angle with single nozzle
- Bulky / Conventional design





Conventional Sanitizer Methods



Heat reduces effectiveness



Always Forget! Not Enough!



Tissue unable to kill gems/ virus



Bulky with high labour cost



Our Smart Features



Smart sensor

Automatic smart induction operation, only need to put your hand under it, it will automatically spray disinfectant according to your hand.

Dual nozzle

Dual nozzle, NOMU Infrared Sanitizer was designated a disinfectant water spray outlet on the side and bottom. The side nozzle is mainly used for disinfection of moving objects such as human hands and courier packaging. The downward nozzle is mainly for the position of the door handle, and back up for side nozzle.

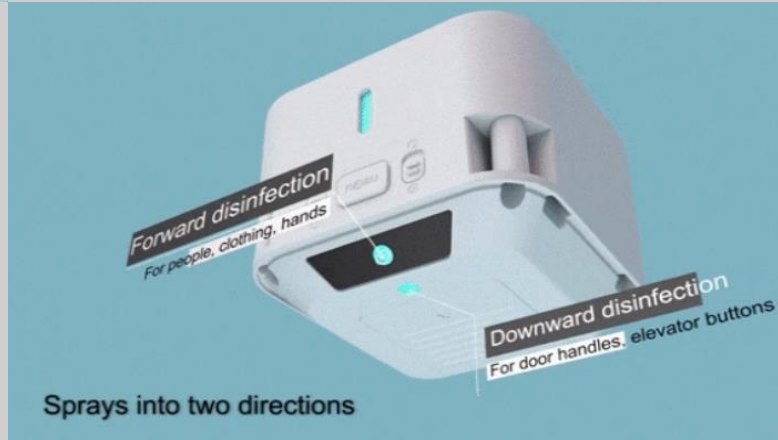

Customize spray metering

Volume adjustment design, you can adjust the spraying volume according to your needs, no matter filled with a pot of disinfectant, or large dose. This device can also be sprayed 200 times, small volume spray can be sprayed 300 times, It is enough to meet weekly spray disinfection need.

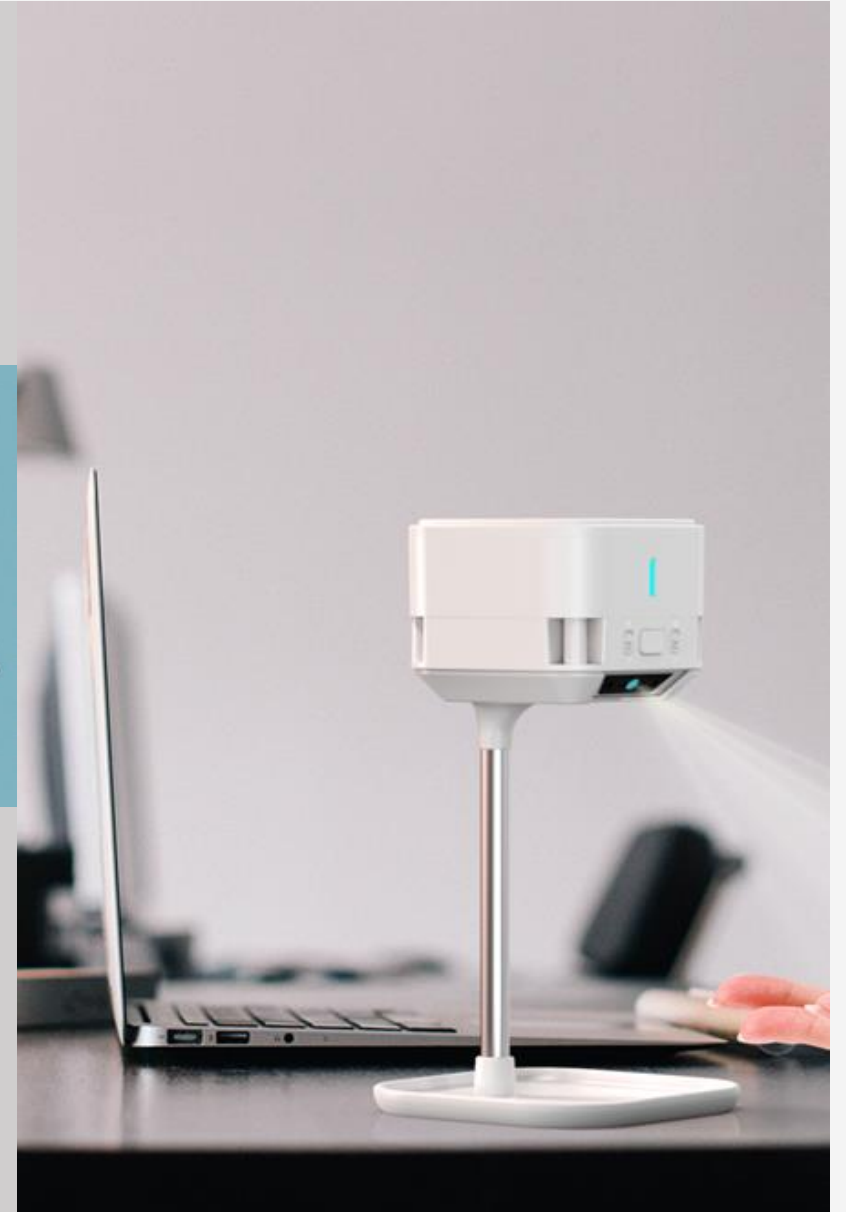



Our Operation Modes



People Mode

In the people mode, when the product detect that an object is approaching within a distance of 0-50CM, it will immediately spray disinfectant, from the object approaching to leaving, only spray once.

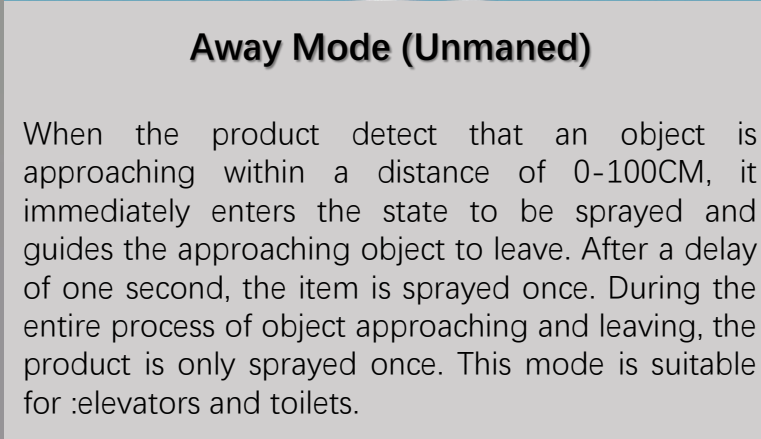

Away Mode (Unmaned)

When the product detect that an object is approaching within a distance of 0-100CM, it immediately enters the state to be sprayed and guides the approaching object to leave. After a delay of one second, the item is sprayed once. During the entire process of object approaching and leaving, the product is only sprayed once. This mode is suitable for elevators and toilets.



Away mode

1m/3ft range

Sprays once more when everyone has left the room

Manual Adjustment Mode

Users can also manually spray an unlimited number of times according to your needs.



Spray time can be set

to 1 or 2 seconds



Smart Dispenser Application Scenarios

Scenario 1

Smart Office



Scenario 2

Public Printing Room



Scenario 3

Home & Office
Door Handles



Scenario 4

Office Pantry



Home

Scenario 5

Protect My Family

disinfection



Scenario 6

Shoes / Jackets Rack



Scenario 6

Washroom



Scenario 7

Retail outlet

Hypermart

Supermarket



Stay Safe . Shop Safe

Scenario 8

Elevator Buttons

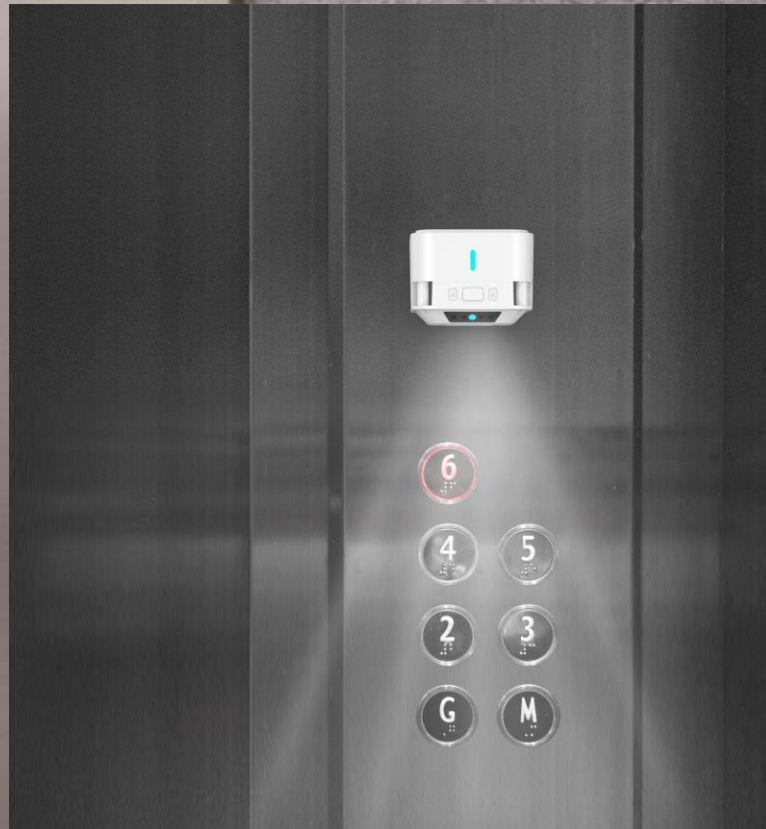

5



ในกรณีเกิดเพลิงไหม้
โปรดใช้บันไดเท่านั้น

In case of fire, use stairs only





Scenario 9

In-Car Protection

Scenario 10

Taxi / Chauffeur



A Safer Journey with Us

The image shows the interior of a public transport vehicle, likely a train or MRT. A series of grey, triangular hanging handles are visible, receding into the distance. In the foreground, a white rectangular sign is attached to a black vertical bar. The sign has the text 'SEPATU DINGIN' and 'VG KEMBALI' in white on a dark background. Below this, there is smaller text in Indonesian. The background is slightly blurred, showing the interior structure of the vehicle, including overhead lighting and other passengers or equipment.

Scenario 11

Buses, Train & MRT Handles



Easy Installation Guide

Paste installation diagram

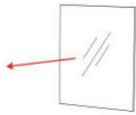
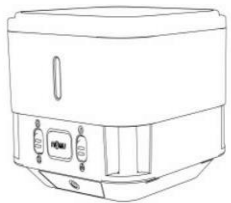
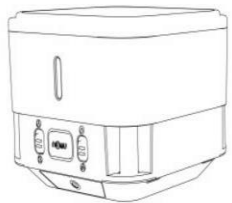

3M Double
sided tape

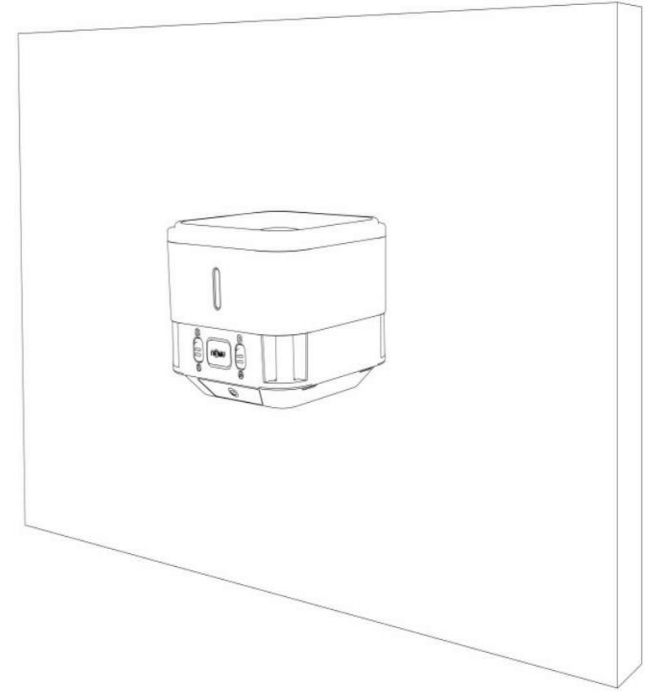

Bracket installation diagram

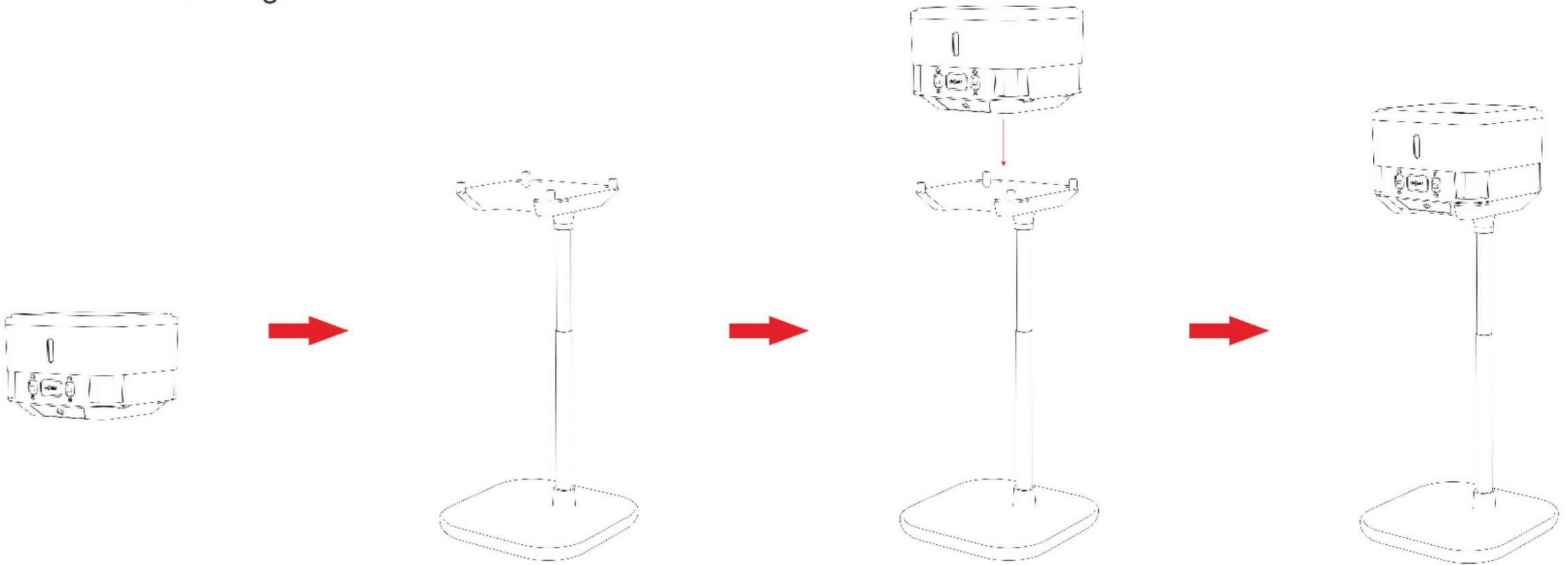

* Stand Bracket may be sold separately

Schematic diagram of lanyard installation

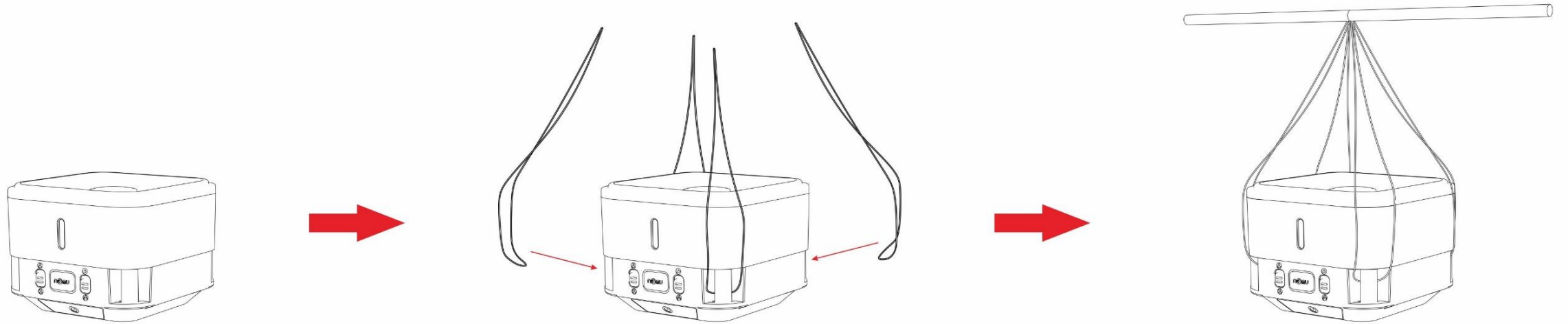

* Lanyard is sold separately



Accessories



Stand Brackets



3M Double Sided Tape



AA Batteries



Dispenser's Packing Info

10 PCS/LOT

SIZE: 620*140*200mm

GROSS WEIGHT: 6.5 KG



6 LOTS/CARTON

SIZE: 640*420*420mm

GROSS WEIGHT: 41 KG

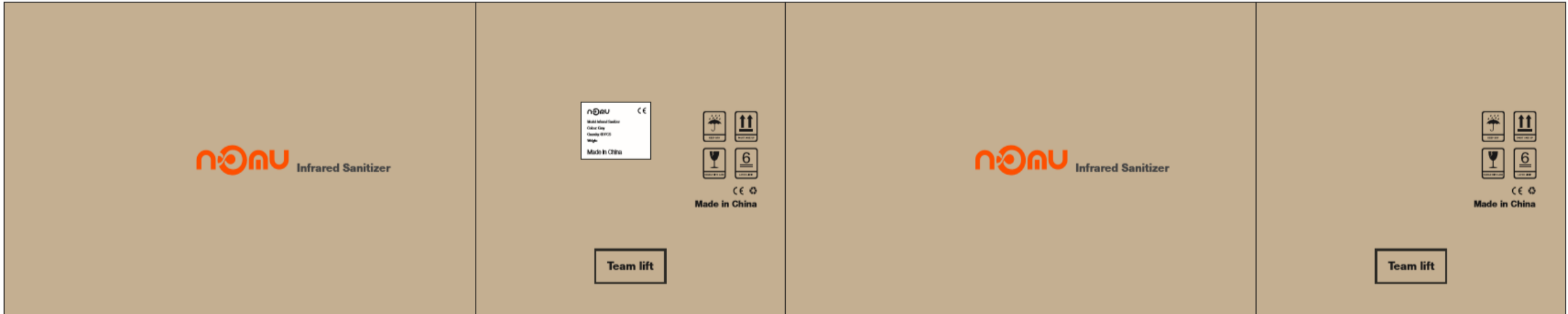



Stand Bracket's Packing Info

10 PCS/LOT

SIZE: 620*180*180mm

GROSS WEIGHT: 4.5KG



6 LOTS/CARTON

SIZE: 640*560*380mm

GROSS WEIGHT: 29 KG

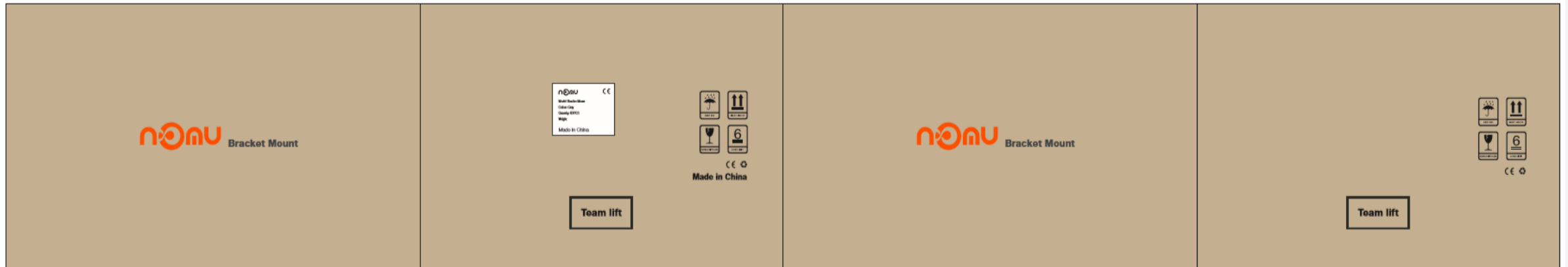

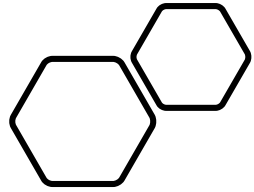

**We Care About
Your Daily
Wellness**

